



VARIOUS PATENTS APPLY

Self Priming Centrifugal Pump

Model T2A3-B

Size 2" x 2"

PUMP SPECIFICATIONS

Size: 2" x 2" (51 mm x 51 mm) NPT - Female.

Casing: Gray Iron 30.

Maximum Operating Pressure 79 psi (545 kPa).*

Semi-Open Type, Two Vane Impeller: Ductile Iron 65-45-12.

Handles 1 1/2" (38,1 mm) Diameter Spherical Solids.

Impeller Shaft: Alloy Steel 4150.

Shaft Sleeve: Alloy Steel 4130.

Replaceable Wear Plate: Carbon Steel 1026

Removable Cover Plate: Gray Iron 30; 20 lbs. (9 kg).

Seal Plate: Gray Iron 30.

Externally Replaceable Flap Valve: Neoprene w/Steel Reinforcing.

Bearing Housing: Gray Iron 30.

Radial Bearing: Open Single Row Ball.

Thrust Bearing: Open Double Row Ball.

Bearing and Seal Cavity Lubrication: SAE 30 Non-Detergent Oil.

Flanges: Gray Iron 30.

Gaskets: Buna-N, Vegetable Fiber, Cork and Rubber.

O-Rings: Buna-N.

Internal Wetted Hardware: Standard Plated Steel.

External Hardware: Standard Plated Steel.

Brass Pressure Relief Valve.

Bearing and Seal Cavity Oil Level Sight Gauges.

Optional Equipment: Automatic Air Release Valve.

120V/240V Casing Heater. High Pump Temperature

Shutdown Kit. GR Hard Iron Seal Plate. Hardened

Steel Wear Plate. Permalon Seal. Self-Cleaning Wear Plate.

Gray Iron 30 Suction and Discharge Spool Flanges:

2" ASA (**Specify Model T2A3-B /F**).

50 mm DIN 2527 (PN 16) (**Specify Model T2A3-B /FM**).

**Consult Factory for Applications Exceeding Maximum Pressure and/or Temperature Indicated.*



Shown with Optional Suction & Discharge Spool Flanges (Available in ASA or DIN Standard Sizes).

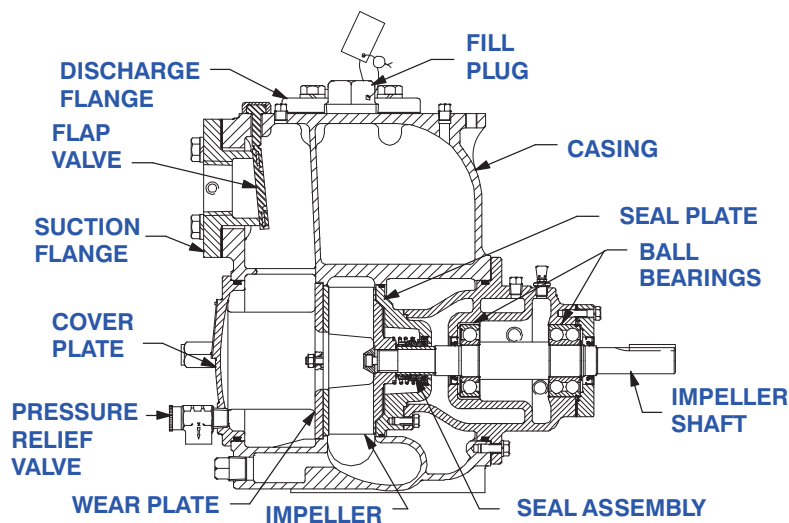
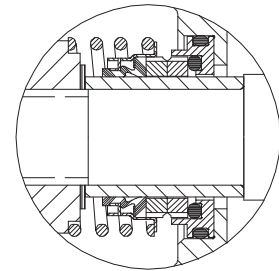

SEAL SPECIFICATIONS

Mechanical, Oil-Lubricated, Double Floating, Self-Aligning. Tungsten Titanium Carbide Rotating and Stationary Faces. Stainless Steel 316 Stationary Seat. Fluorocarbon Elastomers (DuPont Viton® or Equivalent). Stainless Steel 18-8 Cage and Spring. Maximum Temperature of Liquid Pumped, 160°F (71°C).*



THE GORMAN-RUPP COMPANY • MANSFIELD, OHIO

GORMAN-RUPP OF CANADA LIMITED • ST. THOMAS, ONTARIO, CANADA

www.grpumps.com

Specifications Subject to Change Without Notice

Printed in U.S.A.

Specification Data

SECTION 55, PAGE 980

APPROXIMATE DIMENSIONS and WEIGHTS

NET WEIGHT: 210 LBS. (95 KG.)*
SHIPPING WEIGHT: 220 LBS. (10 KG.)*
EXPORT CRATE: 7.9 CU. FT. (0,22 CU. M.)
***ADD 8 LBS. (3,6 KG.) W/EACH SPOOL FLANGE**

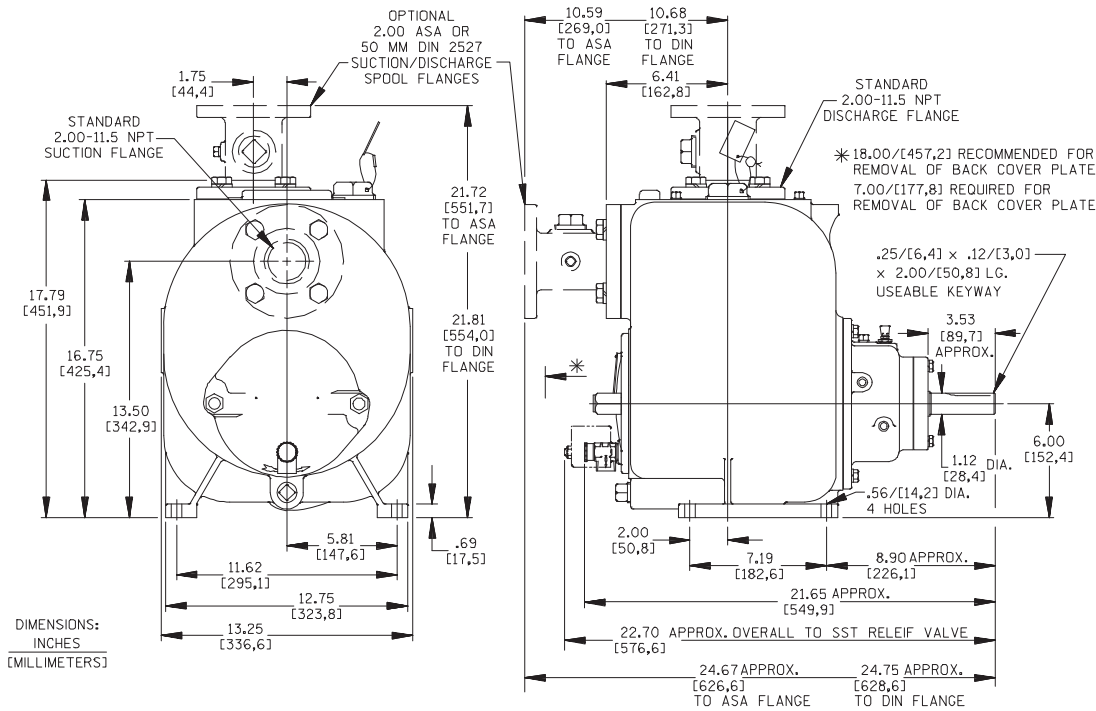

OPTIONAL ASA OR DIN STANDARD SUCTION & DISCHARGE SPOOL FLANGES AVAILABLE

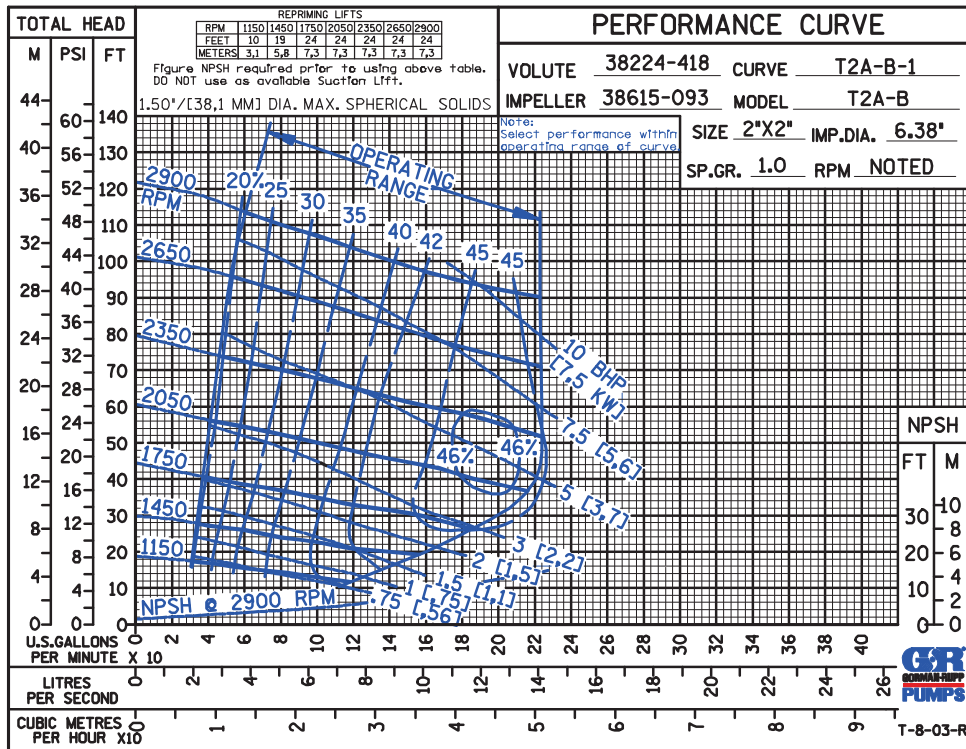

THE GORMAN-RUPP COMPANY • MANSFIELD, OHIO

GORMAN-RUPP OF CANADA LIMITED • ST. THOMAS, ONTARIO, CANADA

Specifications Subject to Change Without Notice

Printed in U.S.A.

Curve Data

Sec. 55

PAGE 988.1
MARCH 2010

CDS

PERFORMANCE CURVE

VOLUTE 38224-418 CURVE T2A-B-1

IMPELLER 38615-093 MODEL T2A-B

SIZE 2"X2" IMP.DIA. 6.38"

SP.GR. 1.0 RPM NOTED

REPRIMING LIFTS

RPM	1150	1450	1750	2050	2350	2650	2900
FEET	10	19	24	24	24	24	24
METERS	3.1	5.8	7.3	7.3	7.3	7.3	7.3

Figure NPSH required prior to using above table.
DO NOT use as available Suction Lift.

1.50" / [38,1 MM] DIA. MAX. SPHERICAL SOLIDS

Note:
Select performance within
operating range of curve.

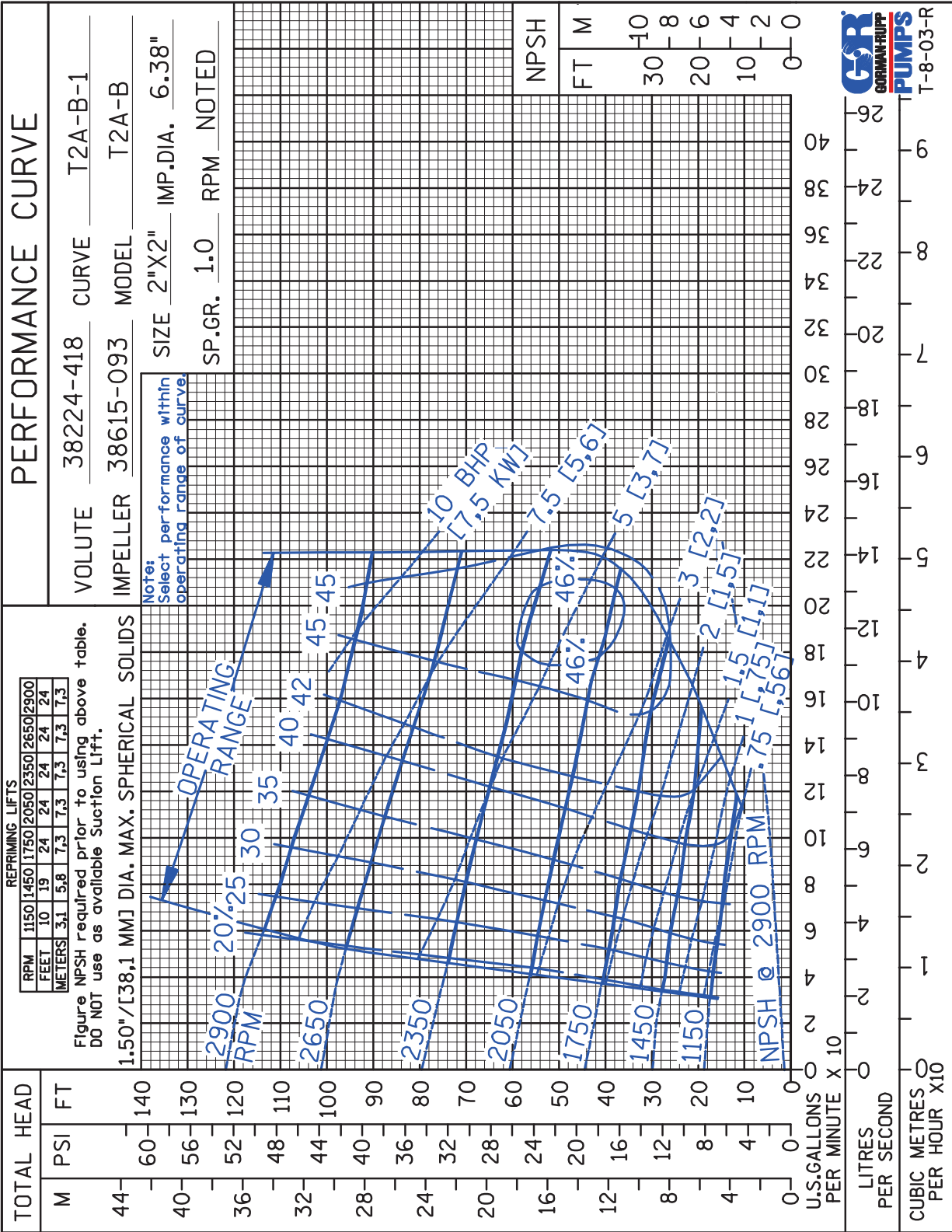

THE GORMAN-RUPP COMPANY • MANSFIELD, OHIO

GORMAN-RUPP OF CANADA LIMITED • ST. THOMAS, ONTARIO, CANADA

www.grpumps.com

Specifications Subject to Change Without Notice

Printed in U.S.A.

Curve Data

CDS

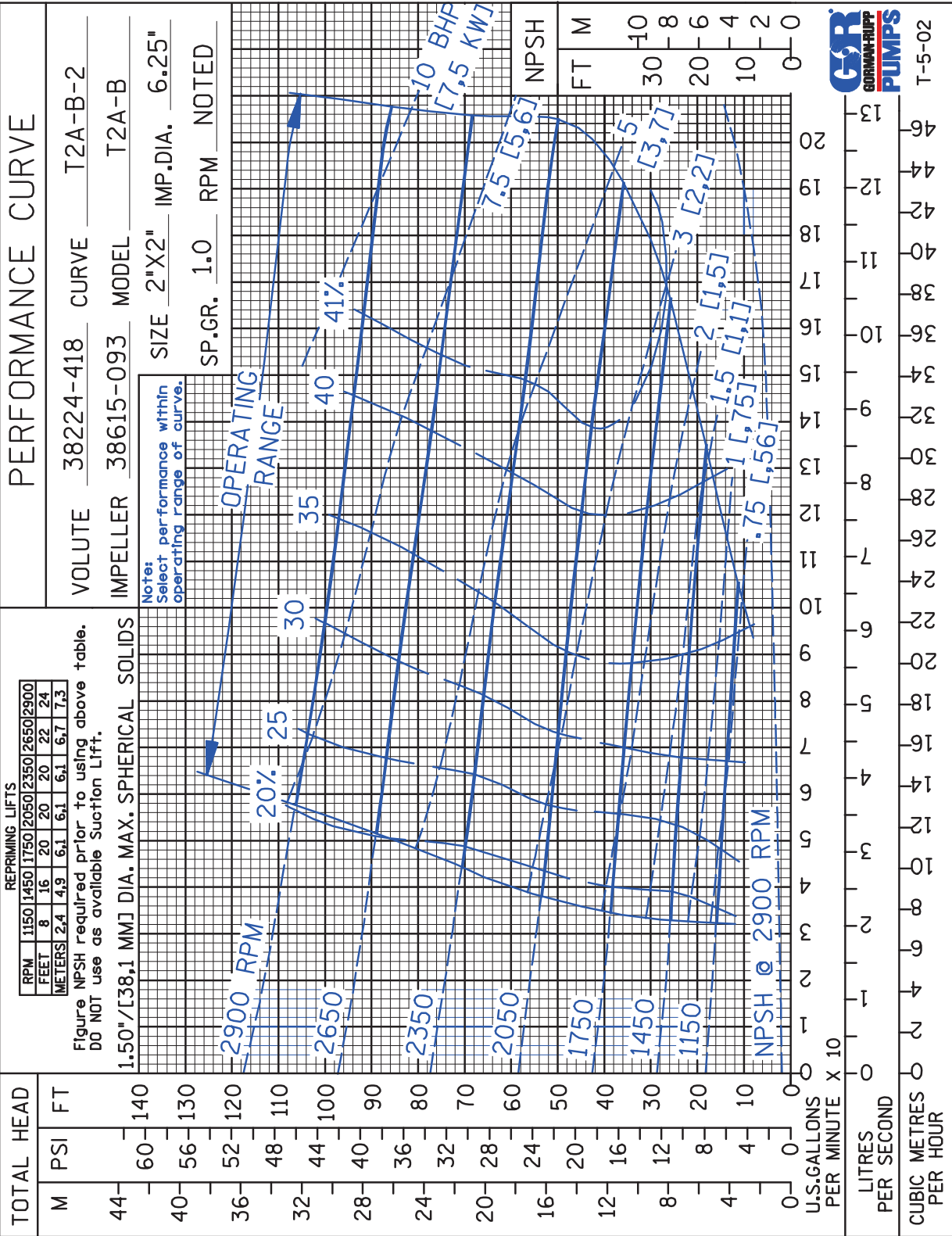

T-5-02



THE GORMAN-RUPP COMPANY • MANSFIELD, OHIO

GORMAN-RUPP OF CANADA LIMITED • ST. THOMAS, ONTARIO, CANADA

www.grpumps.com

Specifications Subject to Change Without Notice

Printed in U.S.A.

CDS

PERFORMANCE CURVE

VOLUTE 38224-418 CURVE T2A-B-3

IMPELLER 38615-093 MODEL T2A-B

SIZE 2"X2" IMP.DIA. 6.00"

SP.GR. 1.0 RPM NOTED

REPRIMING LIFTS

RPM	1150	1450	1750	2050	2350	2650	2900
FEET	6	11	16	18	20	24	28
METERS	1.8	3.4	4.9	5.5	6.1	7.3	8.5

Figure NPSH required prior to using above table.
DO NOT use as available Suction Lift.

1.50"/[38,1 MM] DIA. MAX. SPHERICAL SOLIDS

Note:
Select performance within operating range of curve.

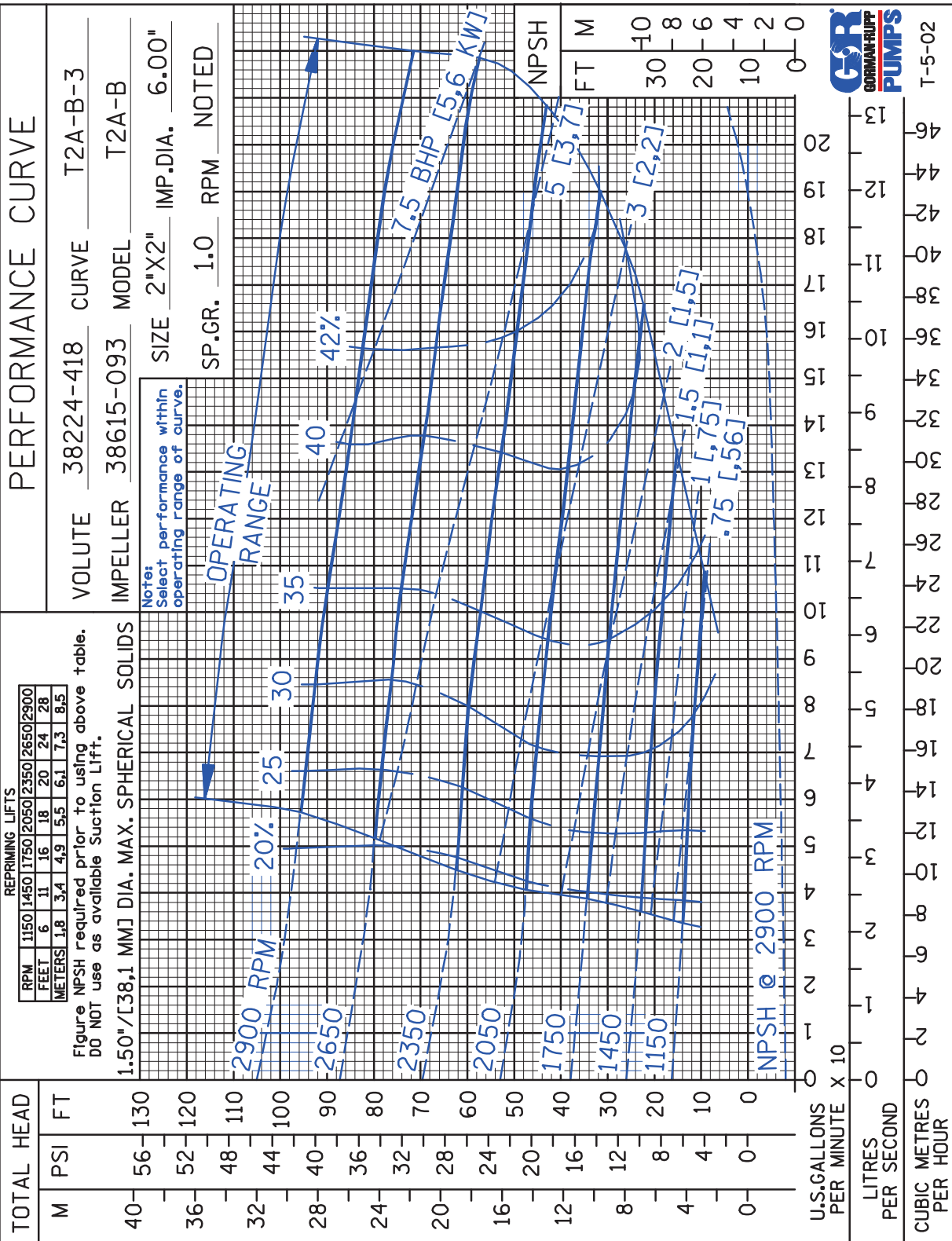

THE GORMAN-RUPP COMPANY • MANSFIELD, OHIO

GORMAN-RUPP OF CANADA LIMITED • ST. THOMAS, ONTARIO, CANADA

www.grpumps.com

Specifications Subject to Change Without Notice

Printed in U.S.A.

CDS

PERFORMANCE CURVE

VOLUTE 38224-418 CURVE T2A-B-4
IMPELLER 38615-093 MODEL T2A-B

SIZE 2"X2" IMP.DIA. 5.75"
SP.GR. 1.0 RPM NOTED

Note:
Select performance within
operating range of curve.

REPRIMING LIFTS

RPM	1150	1450	1750	2050	2350	2650	2900
FEET	4	10	14	16	18	22	27
METERS	1.2	3.1	4.3	4.9	5.5	6.7	8.2

Figure NPSH required prior to using above table.
DO NOT use as available Suction Lift.

1.50"/[38,1 MM] DIA. MAX. SPHERICAL SOLIDS

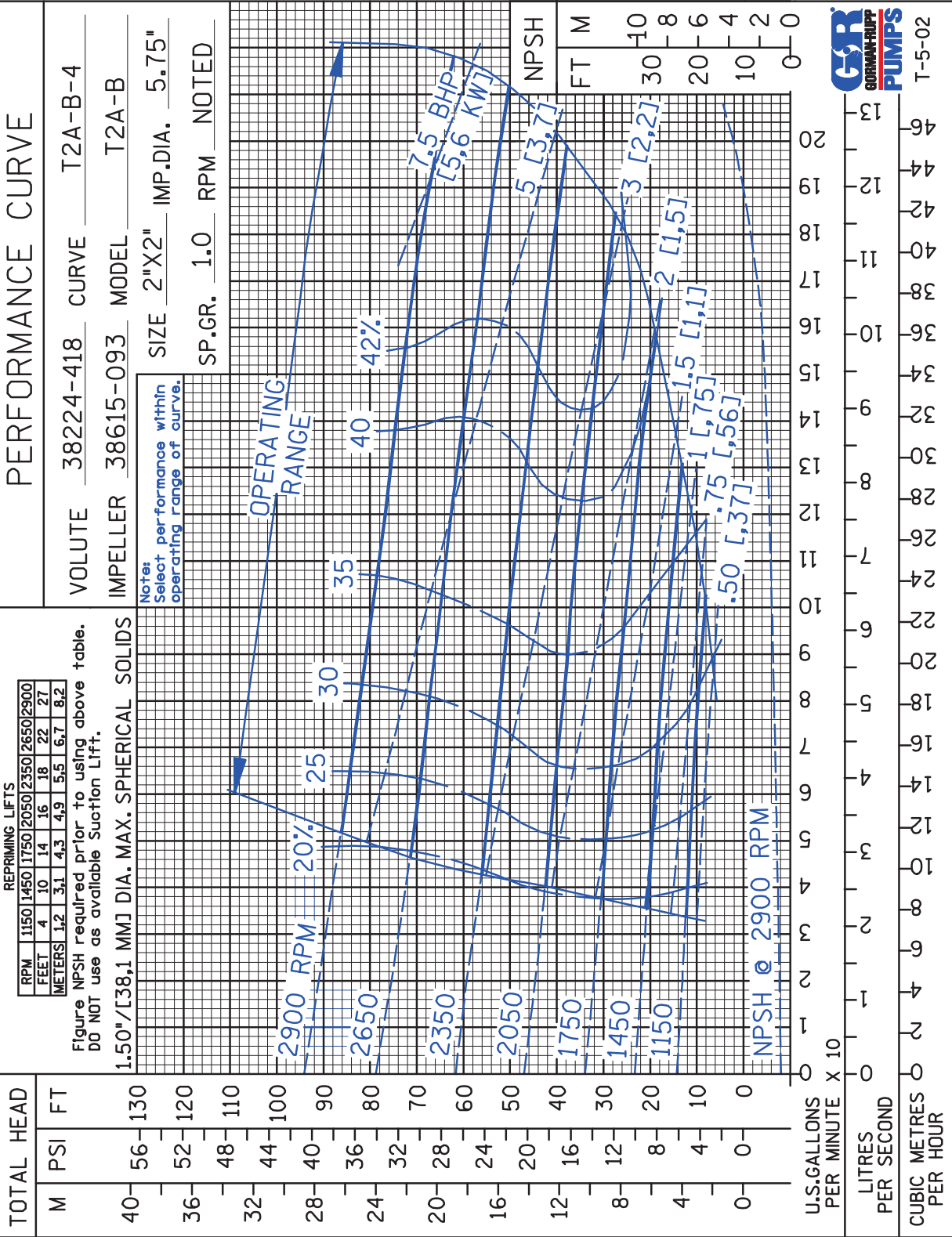

T-5-02



THE GORMAN-RUPP COMPANY • MANSFIELD, OHIO

GORMAN-RUPP OF CANADA LIMITED • ST. THOMAS, ONTARIO, CANADA

www.grpumps.com

Specifications Subject to Change Without Notice

Printed in U.S.A.

CDS

PERFORMANCE CURVE

VOLUTE 38224-418 CURVE T2A-B-5
 IMPELLER 38615-093 MODEL T2A-B
 SIZE 2"X2" IMP.DIA. 5.50"
 SP.GR. 1.0 RPM NOTED

REPRIMING LIFTS

RPM	1150	1450	1750	2050	2350	2650	2900
FEET	4	8	12	12	15	20	26
METERS	1.2	2.4	3.7	3.7	4.6	6.1	7.9

Figure NPSH required prior to using above table.
 DO NOT use as available Suction Lift.

1.50"/[38,1 MM] DIA. MAX. SPHERICAL SOLIDS

Notes:
 Select performance within
 operating range of curve.

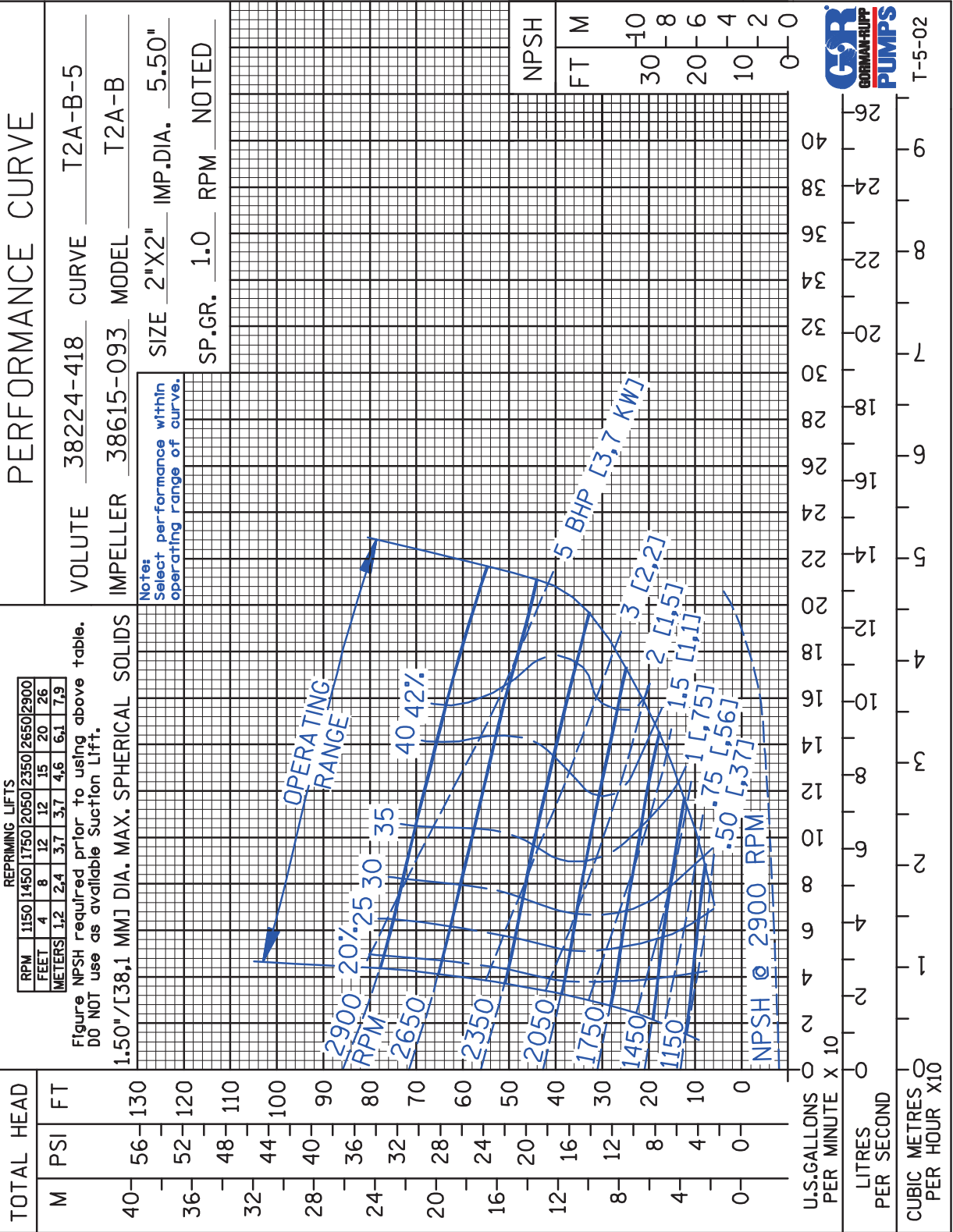

T-5-02



THE GORMAN-RUPP COMPANY • MANSFIELD, OHIO

GORMAN-RUPP OF CANADA LIMITED • ST. THOMAS, ONTARIO, CANADA

www.grpumps.com

Specifications Subject to Change Without Notice

Printed in U.S.A.

Curve Data

Sec. 55

PAGE 988.6

MARCH 2010

CDS

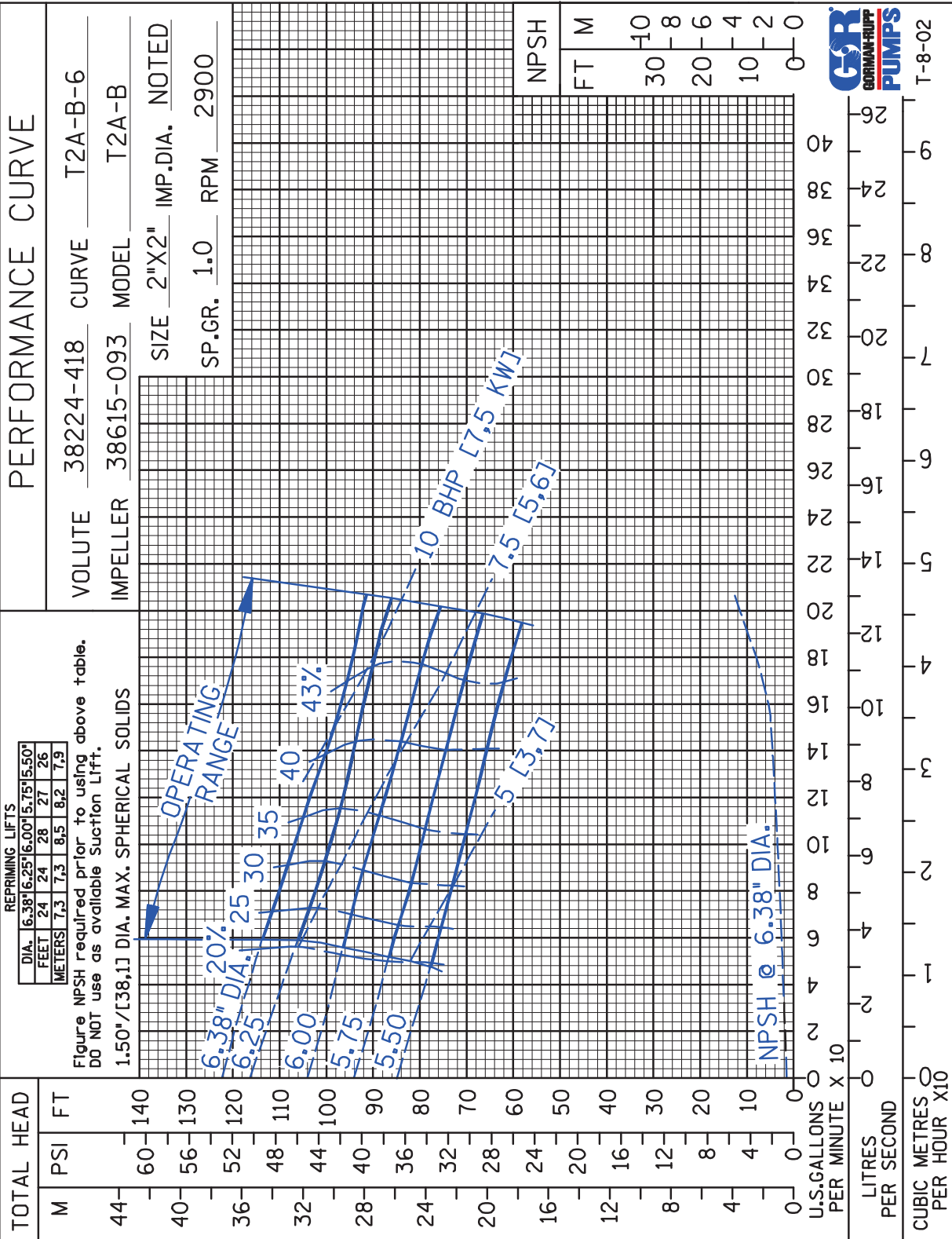

THE GORMAN-RUPP COMPANY • MANSFIELD, OHIO

GORMAN-RUPP OF CANADA LIMITED • ST. THOMAS, ONTARIO, CANADA

www.grpumps.com

Specifications Subject to Change Without Notice

Printed in U.S.A.

CDS

PERFORMANCE CURVE

VOLUTE 38224-418 CURVE T2A-B-7
 IMPELLER 38615-093 MODEL T2A-B
 SIZE 2"X2" IMP.DIA. NOTED
 SP.GR. 1.0 RPM 1450

REPRIMING LIFTS

DIA.	16.38"	16.25"	16.00"	15.75"	15.50"
FEET	19	16	11	10	8
METERS	5.8	4.9	3.4	3.1	2.4

Figure NPSH required prior to using above table.
 DO NOT use as available Suction Lift.
 1.50' / [38,1] DIA. MAX. SPHERICAL SOLIDS

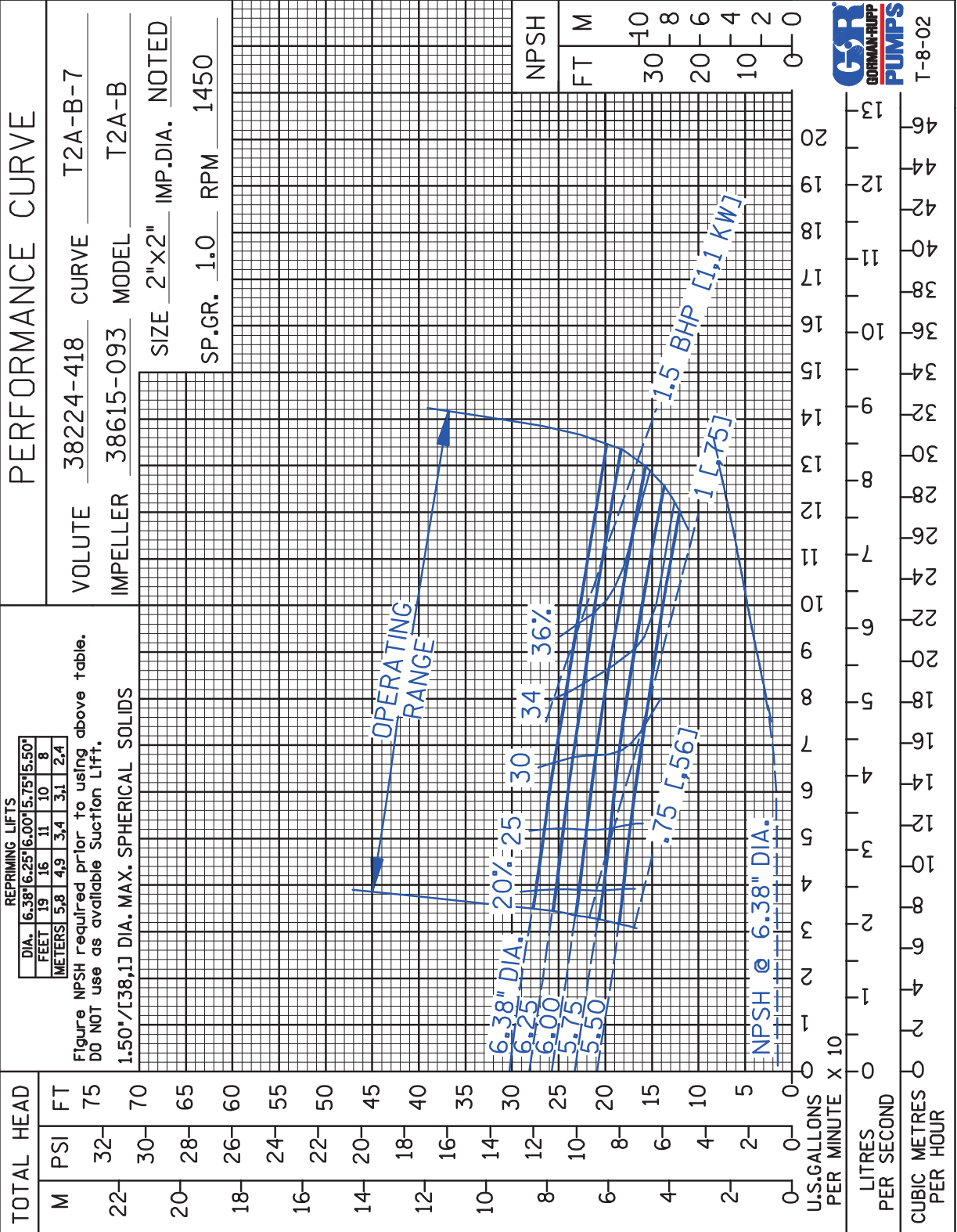

T-8-02



THE GORMAN-RUPP COMPANY • MANSFIELD, OHIO

GORMAN-RUPP OF CANADA LIMITED • ST. THOMAS, ONTARIO, CANADA

www.grpumps.com

Specifications Subject to Change Without Notice

Printed in U.S.A.

Curve Data

Sec. 55

PAGE 988.8

MARCH 2010

CDS

PERFORMANCE CURVE

VOLUTE 38224-418 CURVE T2A-B-8
 IMPELLER 38615-093 MODEL T2A-B
 SIZE 2"X2" IMP.DIA. NOTED
 SP.GR. 1.0 RPM 1750

Note:
 Select performance within
 operating range of curve.

REPRIMING LIFTS

DIA.	1.638	1.625	1.600	1.575	1.550
FEET	24	20	16	14	12
METERS	7.3	6.1	4.9	4.3	3.7

Figure NPSH required prior to using above table.
 DO NOT use as available Suction Lift.

1.50"/[38,1 MM] DIA. MAX. SPHERICAL SOLIDS

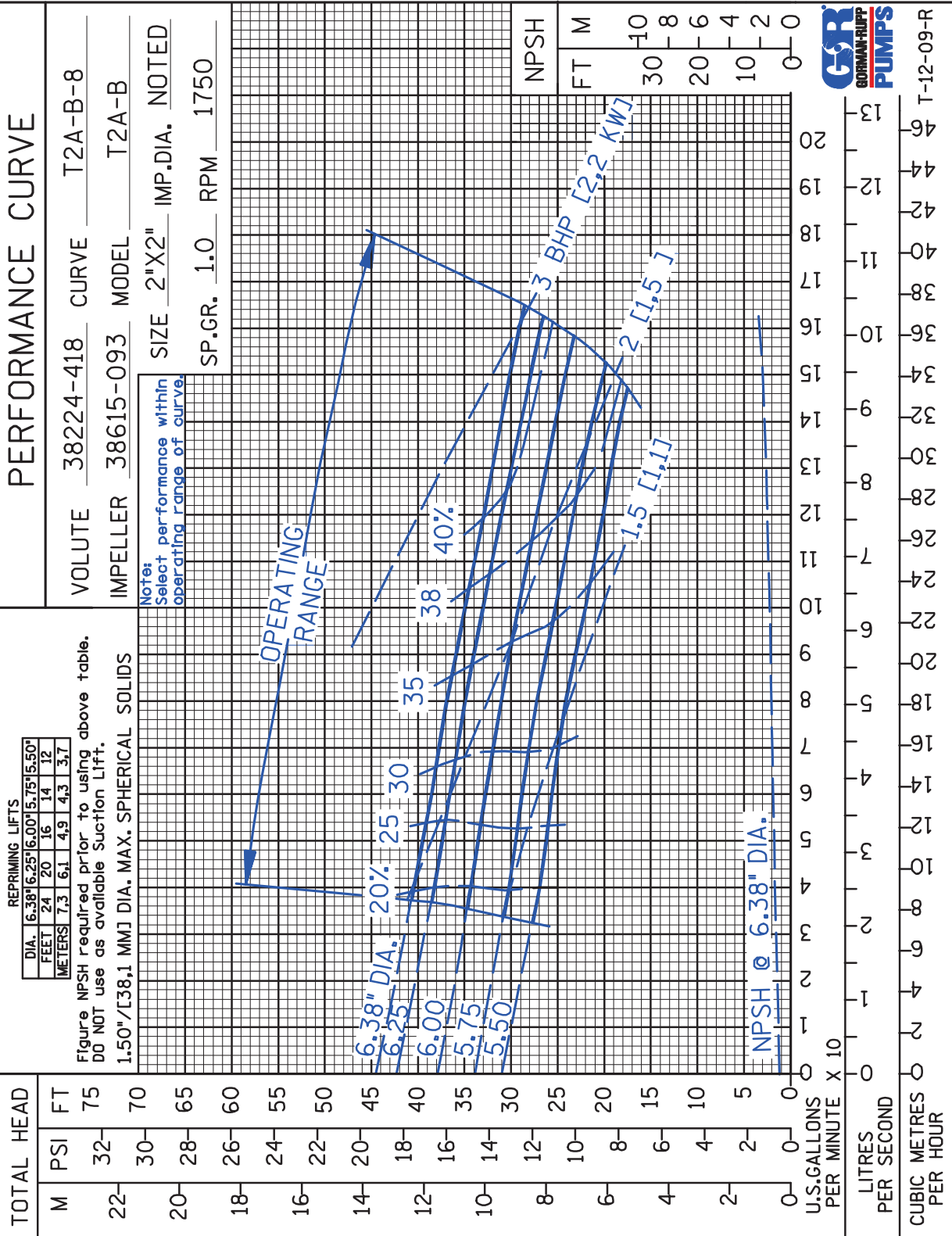

THE GORMAN-RUPP COMPANY • MANSFIELD, OHIO

GORMAN-RUPP OF CANADA LIMITED • ST. THOMAS, ONTARIO, CANADA

www.grpumps.com

Specifications Subject to Change Without Notice

Printed in U.S.A.

CDS

PERFORMANCE CURVE

VOLUTE 38224-418 CURVE T2A-B-9
 IMPELLER 38615-093 MODEL T2A-B
 SIZE 2"X2" IMP.DIA. NOTED
 SP.GR. 1.0 RPM 1150

REPRIMING LIFTS
 DIA. 16.38 16.25 16.00 15.75 15.50"
 FEET 10 8 6 4
 METERS 3.1 2.4 1.8 1.2 1.2

Figure NPSH required prior to using above table.
 DO NOT use as available Suction Lift.
 1.50"/[38,1 MM] DIA. MAX. SPHERICAL SOLIDS

Note:
 Select performance within
 operating range of curve.

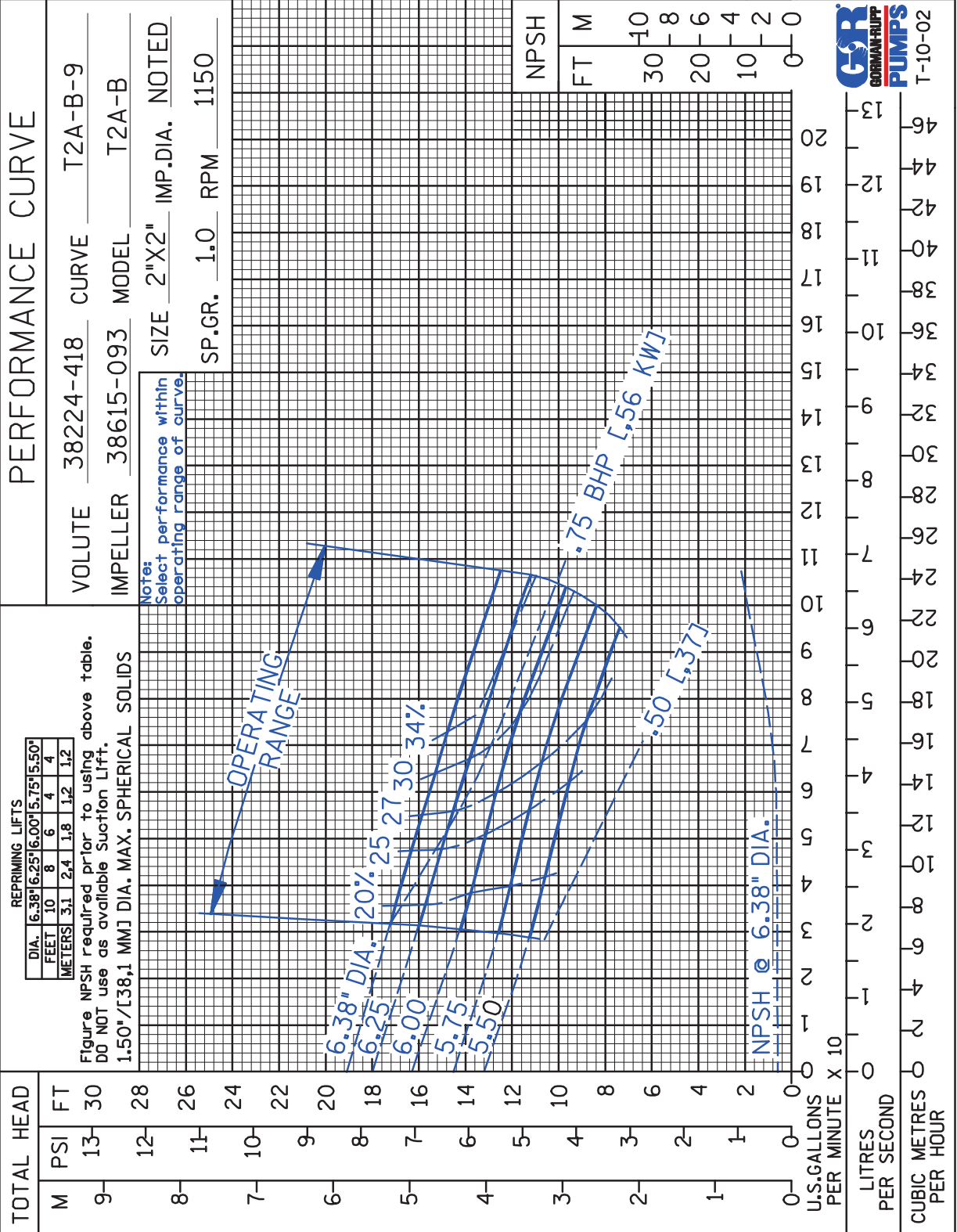

THE GORMAN-RUPP COMPANY • MANSFIELD, OHIO

GORMAN-RUPP OF CANADA LIMITED • ST. THOMAS, ONTARIO, CANADA

www.grpumps.com

Specifications Subject to Change Without Notice

Printed in U.S.A.

Curve Data

Sec. 55

PAGE 988.10
MARCH 2010

CDS

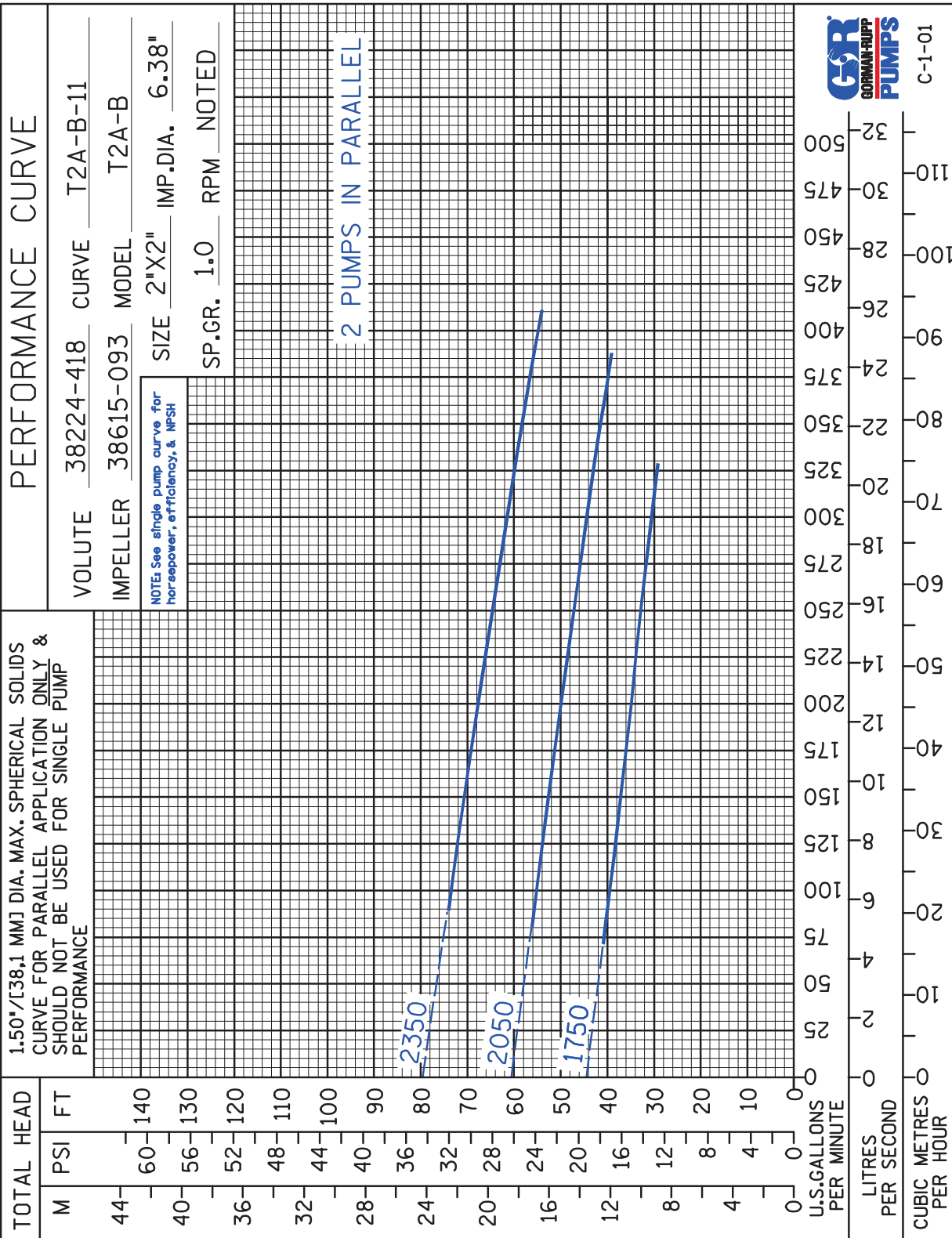

THE GORMAN-RUPP COMPANY • MANSFIELD, OHIO

GORMAN-RUPP OF CANADA LIMITED • ST. THOMAS, ONTARIO, CANADA

www.grpumps.com

Specifications Subject to Change Without Notice

Printed in U.S.A.

Curve Data

Sec. 55

PAGE 988.11
MARCH 2010

CDS

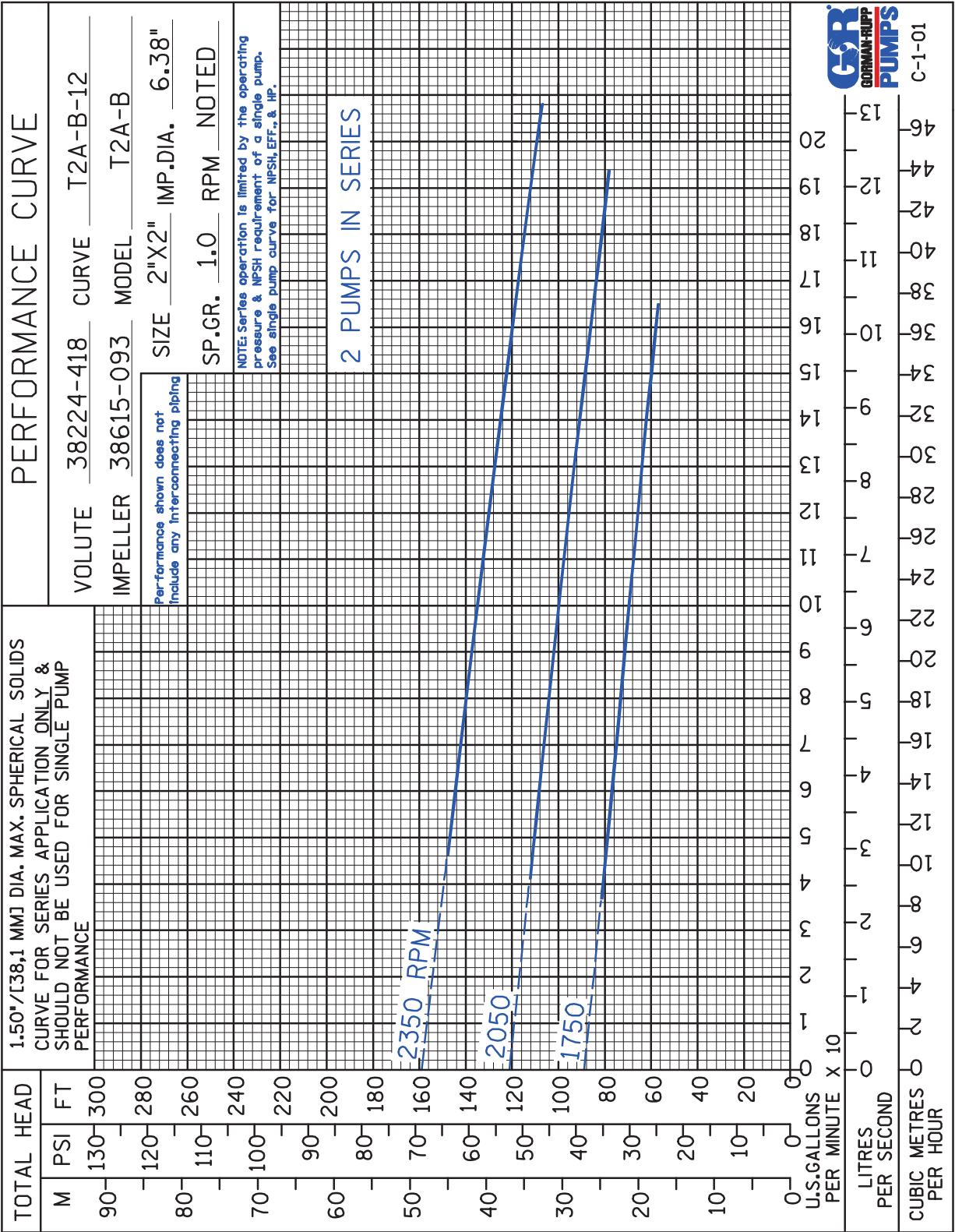

THE GORMAN-RUPP COMPANY • MANSFIELD, OHIO

GORMAN-RUPP OF CANADA LIMITED • ST. THOMAS, ONTARIO, CANADA

www.grpumps.com

Specifications Subject to Change Without Notice

Printed in U.S.A.